











Product datasheet

Product name Internal extractor with segmented grasp edge
Product number 21-4-E
Product series
EAN 4021176909191



Technical attributes

| Attribute name | Attribute value |
|--|---|
|  ball bearing ISO | 6005; 6205; 6305; 6405; 6805; 6905; 16005; 61805; 61905; 6006; 6206; 6306; 6406; 16006; 61806; 61906 |
|  inner diameter of ball bearing | 24 - 34 mm (7/8 - 1 3/8 inch) |
|  effective depth | 58 mm (2 1/4 inch) |
|  length of internal extractor | 98 mm (3 7/8 inch) |
|  number of segments | 4 |
|  not found or type unknown | 17 SW |
|  not found or type unknown | 22 SW |
|  weight | 0.3 kg |

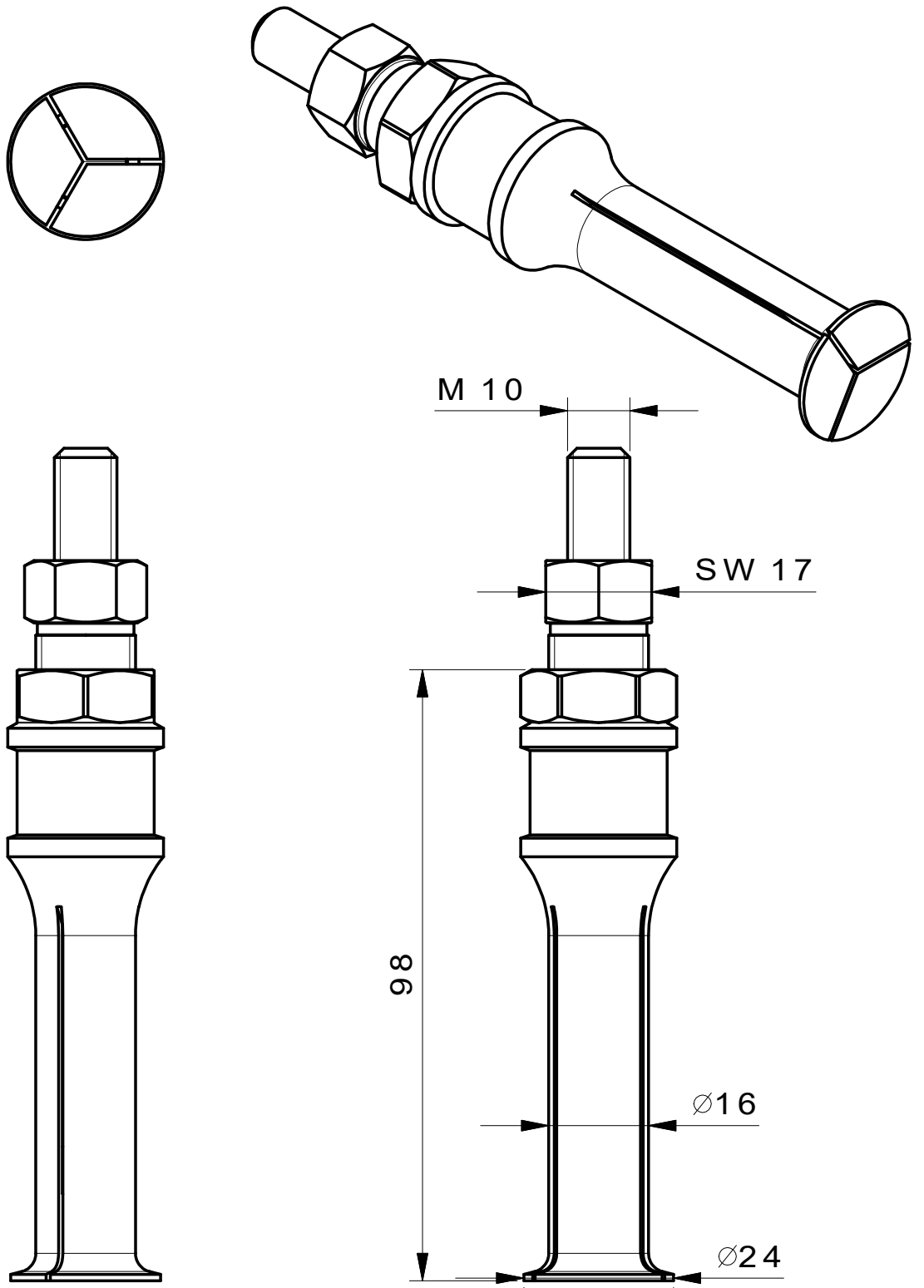

**Kleinbongartz
& Kaiser
oHG**
Werkzeugfabrik
Hilden - Germany

Dokumentname:
21-4-E_Segment-Innenauszieher

Toleranz:
DIN ISO 2768-m

Dokumentbeschreibung:
Baugruppe

Material:
Hochfester extra zäher Vergütungsstahl/
High tensile strength and toughness steel

Erstellt von:
Breidenbach

Erstellungsdatum:
09/02/2017

Maßstab:
1:1

Teilbeschreibung:

Segment-Innenauszieher/ Internal extractor with segmented grasp edge

Wärmebehandlung / Härte:
vergüteter Stahl/ tempered steel

Oberflächenbehandlung:

Artikelnummer / ZNR.:
21-4-E

Dokumentversion:
-

Schutzvermerk
ISO 16016
beachten