



Product datasheet

Product name Internal extractor with segmented grasp edge









Product number 21-3-E

Product series

EAN 4021176931109



Technical attributes

Attribute name	Attribute value
 ball bearing ISO	6004; 6204; 6304; 6404; 6804; 6904; 16004; 61804; 61904
 inner diameter of ball bearing	18 - 23 mm (3/4 - 7/8 inch)
 effective depth	50 mm (2 inch)
 length of internal extractor	90 mm (3 1/2 inch)
 number of segments	3
 not found or type unknown	14 SW
 not found or type unknown	22 SW
 weight	0.2 kg

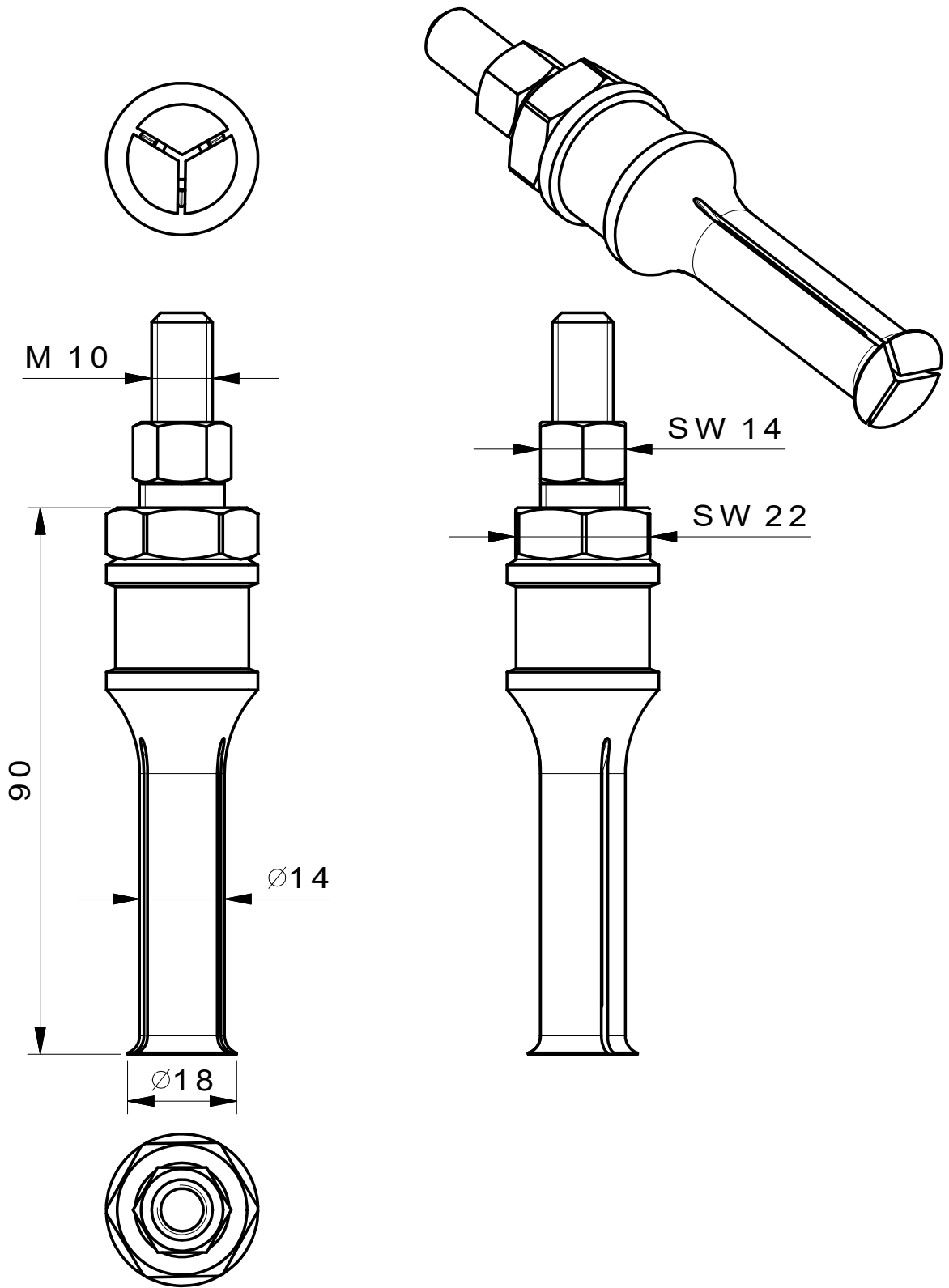

 <p>Kleinbongartz & Kaiser oHG Werkzeugfabrik Hilden - Germany</p>	Dokumentname: 21-3-E_Segmentinnenauszieher		Toleranz: DIN ISO 2768-m	
	Dokumentbeschreibung: Baugruppe		Material: Hochfester extra zäher Vergütungsstahl/ High tensile strength and toughness steel	
	Erstellt / Geprüft von: Schultes	Erstellungsdatum: 21/09/2015	Maßstab: 1:1	
Teilbeschreibung: Segment-Innenauszieher/ Internal extractor with segmented grasp edge			Wärmebehandlung / Härte: vergüteter Stahl/ tempered steel	
			Oberflächenbehandlung:	
Artikelnummer / ZNR.: 21-3-E	Dokumentversion: -		Schutzvermerk ISO 16016 beachten	