











# Product datasheet

**Product name** Internal extractor with segmented grasp edge  
**Product number** 21-1-E  
**Product series**  
**EAN** 4021176930003



## Technical attributes

Attribute name	Attribute value
 ball bearing ISO	6001; 6201; 6301; 6801; 6901; 16001; 16101; 61801; 61901; 62201; 62301; 6002; 6202; 6302; 6802; 6902; 16002; 61802; 61902
 inner diameter of ball bearing	12 - 16 mm (3/16 - 5/8 inch)
 effective depth	35 mm (1 3/8 inch)
 length of internal extractor	80 mm (3 3/16 inch)
 number of segments	3
 not found or type unknown	14 SW
 not found or type unknown	22 SW
 weight	0.2 kg

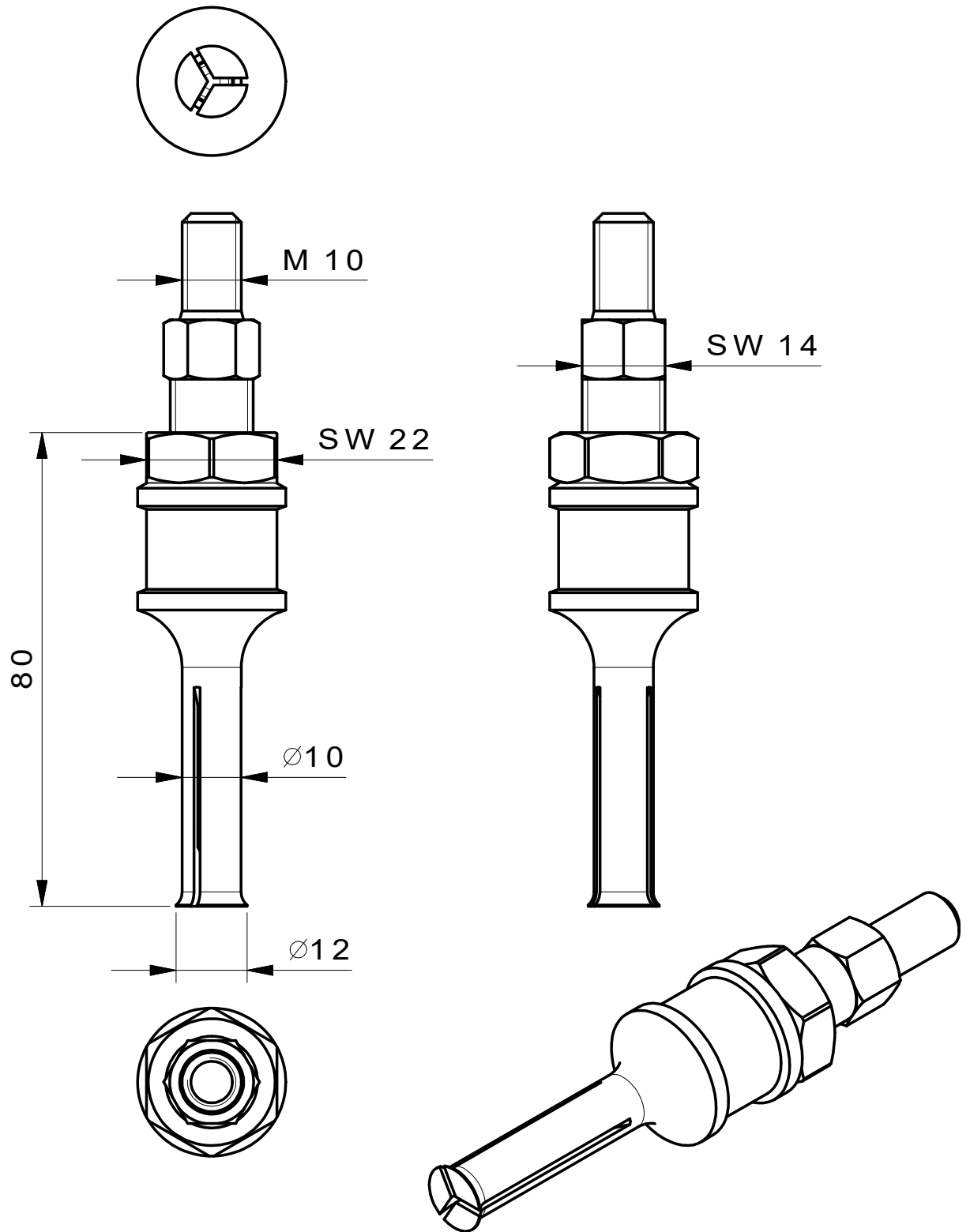

**Kleinbongartz  
& Kaiser  
oHG**  
Werkzeugfabrik  
Hilden - Germany

Dokumentname:  
21-1-E\_Segment-Innenauszieher

Toleranz:  
DIN ISO 2768-m

Dokumentbeschreibung:  
Baugruppe

Material:  
Hochfester extra zäher Vergütungsstahl/  
High tensile strength and toughness steel

Erstellt von:  
Breidenbach

Erstellungsdatum:  
10/05/2016

Maßstab:  
1:1

Teilbeschreibung:

Segment-Innenauszieher/ Internal extractor with segmented grasp edge

Wärmebehandlung / Härte:  
vergüteter Stahl/ tempered steel

Oberflächenbehandlung:

Artikelnummer / ZNR.:  
21-1-E

Dokumentversion:  
-

Schutzvermerk  
ISO 16016  
beachten